

AMT

ALFING MONTAGETECHNIK

FIXTURE SPINDLE TECHNOLOGY

Product catalog

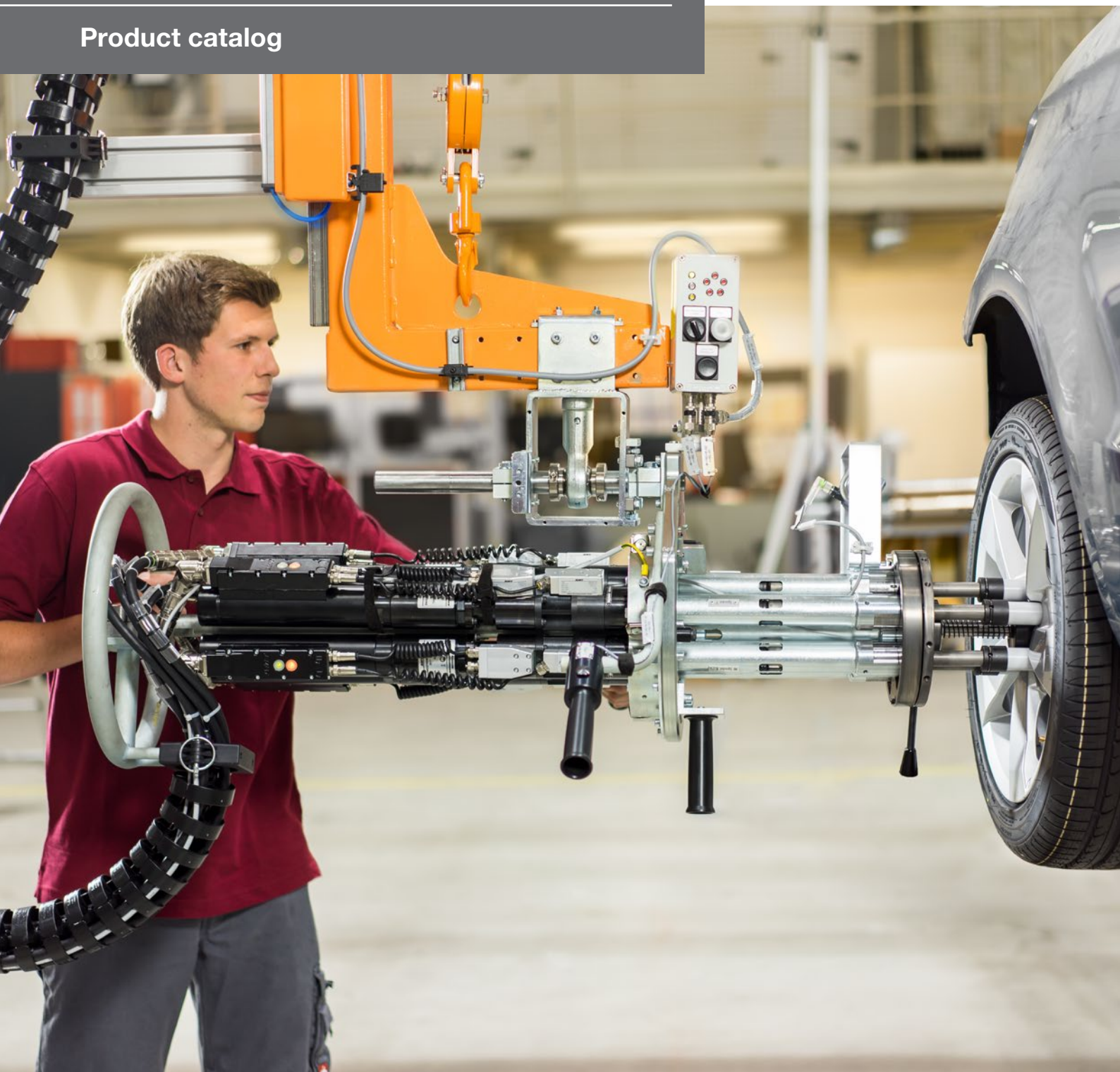

THE ALFING SONDERMASCHINEN-GROUP



Aerial image AMT & AKS – ALFING-Sondermaschinen-Group 2017

History – The ALFING-Sondermaschinen-Group through the years

1938

Incorporation of Alfing Kessler Sondermaschinen GmbH (AKS). Worldwide, the company is regarded as a leader in technology for rotary transfer machines, turning centers, fracture splitting Systems and machines for connecting rod processing.

1981

Incorporation of Alfing Montage-technik GmbH (AMT). The new division focuses on technologically sophisticated special solutions such as fastening technology, assembly machines and automation. A German Specialist for the world market.

1992

Alfing establishes a sales and service office in the USA. The American industry values leading German technology as well as comprehensive on site consulting and support.

THE ALFING SONDERMASCHINEN-GROUP

The ALFING Sondermaschinen Group is made of two producing companies: Alfin Kessler Special Machines (AKS) and Alfin Montagetechnik GmbH (AMT) as well as the sales and service branches of Alfin Corporation (USA) and Alfin Machine Tools, China. AKS and AMT are jointly managed and are closely interrelated in the fields of development, design and production. Common cross-departmental functions, e.g. Finance, Human Resources, Purchasing and IT were merged and now support both companies. With more than 500 employees, the Group generates an annual turnover of approx. 100 million Euro.

AMT - leading specialist for fastening technology, assembly and leak-testing systems and automation

Our globally top ranking position is based on the continuous development of more precise, intelligent and energy efficient assembly systems for safety and quality critical fastening.

Also, our technical expertise in conception and construction of manual, semi-automated and fully automatic assembly systems makes us a sought-after partner worldwide for the automotive industry and its suppliers.

In addition, we develop individual leak testing systems, tailored to your requirements, your production environment and your business environment. To this end, we combine proven solutions and integrate them into an efficient overall process.

Our automation unit develops complex solutions for the automated loading and unloading of machines as well as their interlinking.

AKS – World leader in Connecting rod processing

AKS stands for special machines and machining centers world-wide for connecting rod processing as well as assembly and Fracture splitting machines. They are mostly used in the workshops of the major automobile manufacturers and suppliers.

Focused competence, constant innovation and numerous patents from more than 75 years of mechanical engineering make AKS the world's leading supplier for everything related to connecting rod processing.

The constant striving for uncompromisingly precise, fast and reliable high-tech solutions leads to our new generation of AX, AT and AF rod machining machines.

2009

Alfin establishes a Service-subsidiary in China. Our Asian customers will also benefit from prompt assistance that is comparable to the European and American service levels.

2016

The ALFING-Sondermaschinen-Group generated a turnover of approx. 100 million Euro with 500 employees.

Opinion

Precise workmanship and continuous innovations have made Alfin a technology leader. Worldwide We will be by your side As a reliable solutions coordinator.

AMT FASTENING TECHNOLOGY

Powerful, intelligent, efficient

Nutrunners from AMT are the ideal choice if critical safety fastening must be made with high precision and of uniform quality. As a partner to the automotive industry, AMT offers innovative and strong nutrunner systems that can easily meet the high requirements of the customers.

Safety in the assembly process

The quality of as fastening does not depend solely on the use of high-quality tools, but also on the employees who use them. When designing solutions for our customers, we consider not only the individual fastening, but also the people and the design of their workspace. The avoidance of errors through a suitable workspace design and the detection of errors through innovative monitoring strategies are in the foreground.

Everything from a single source

Alfing Montagetechnik provides the right nutrunner technology and complete peripherals for your workstations; from simple telescopes to complex semi-automatic handling devices. AMT is able to supply hand-held multi-nutrunners, fixture nutrunners or complete assembly units because of special machine construction. AMT assumes the design, construction, assembly and commissioning. As an installation engineering company driven by passion, we have kept in mind the human factor: We assist you in the design and set-up of up-to-date ergonomic and employee friendly Workstations and systems.

It is clear why many customers decide for assembly technology from AMT. One contact for all tasks dealing with the assembly technology reduces the planning and coordination efforts and therefore the costs.



Communication with mobile end devices

The new control generation allows for the greatest possible freedom and can be operated at any given time from any given location. The access to the control is carried out through a network connection and a browser-enabled end device.

Programming, error diagnosis, and maintenance- each action is now possible in the new generation nutrunner independent of the location and time. In the case of fault messages, the operator is able to access the control directly via the mobile terminal. This convenient operation saves channels and money.

Another innovation is the QR code attached to the controller. If it is scanned by a mobile terminal, the connection is established to the control.

Easy operation

It will no longer be necessary to install special software on a PC or a mobile device for settings or to program fastening control. The new integrated web server frees the nutrunner world from compatibility and updating problems of the past. The control hardware already contains the required programming software. The only thing that our customers need in the future is a web browser - the user interface of the control will be displayed on any end device. Be it PC or smart phone - the image is adjusted to the display of the end device being used.

Energy efficient

The heart of your new nutrunner control is a powerful Low-Power-Processor. The new low loss power amplifiers as well as the new individual switch-off control components for standby operation reduce your energy requirements significantly. The new generation AMT nutrunner technology reduces your energy costs by up to 75 % compared to its predecessor.



FIXTURE SPINDLE TECHNOLOGY

Modular construction

The ESX Fixture Spindles have a modular design, this means individual components like measurement transducers or output can be combined together as needed. Furthermore, the cable connection can be gradually adjusted to the respective installation situation of the spindle with the innovative rotating joint hybrid plug.

Digital communication

The ESX Fixture Spindles communicate digitally with the control. As the number of wires are reduced, the spindle cable is thin, flexible and light. Even with redundant constructions with two measurement transducer for the torque and rotational angle recording, the spindle is only connected to the control through a hybrid cable for data and performance.

Integrated status display

The status display integrated in the spindle comes with several advantages. The operation and communication status as well as the quality statement of the last tightening application are displayed through LEDs. Through this, the diagnosis of disruptions is simplified greatly and if the spindle is used in a handling device, a separate display panel is not required.

Maintenance management

Using the integrated maintenance management, the Tool maintenance is worked out depending on the load. Maintenance must be carried out only if it is required.

Action torque sensor

The AMT Fixture Spindles stand for the highest precision during the tightening process. This is ensured by action torque sensors to detect the torque - directly on the output shaft, i.e., as close as possible to the actual fastener position.

Any changes in effectiveness in the angle or offset drives due to wear have no influence on the tightening torque. If the tightening torque is achieved, the fastening application will be executed securely independent of the mechanical condition of the drive.

More sensors for better process reliability

The VDI Guideline 2862 recommends the use of a redundant sensor system for class A fastening connections. AMT spindles record the fastening values of these variants as follows:

- Control circuit:** Torque recording by action torque sensor with angle transmitter
- Check circuit:** Reaction torque sensor, angle recording using rotor bearing

By continuously monitoring the measured values, the time interval between the dynamic reference measurements can be significantly extended by means of a plug-in torque sensor.

ESX CENTRIC OUTPUT

Page 10

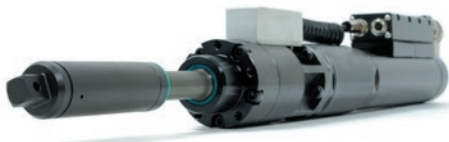

ESX OFFSET OUTPUT

Page 14



ESX ANGLE OUTPUT

Page 18





**COMPACT
NUTRUNNER KSX**

Page 24



CONTROLS

Page 26



CABLES

Page 34



ACCESSORIES

Page 38



FIXTURE SPINDLE TECHNOLOGY

Fixture Spindles from AMT set standards with regard to precision, performance and reliability. Therefore they are the first choice when you require a fast process time and highest accuracy while fastening and high availability of the tools are indispensable.

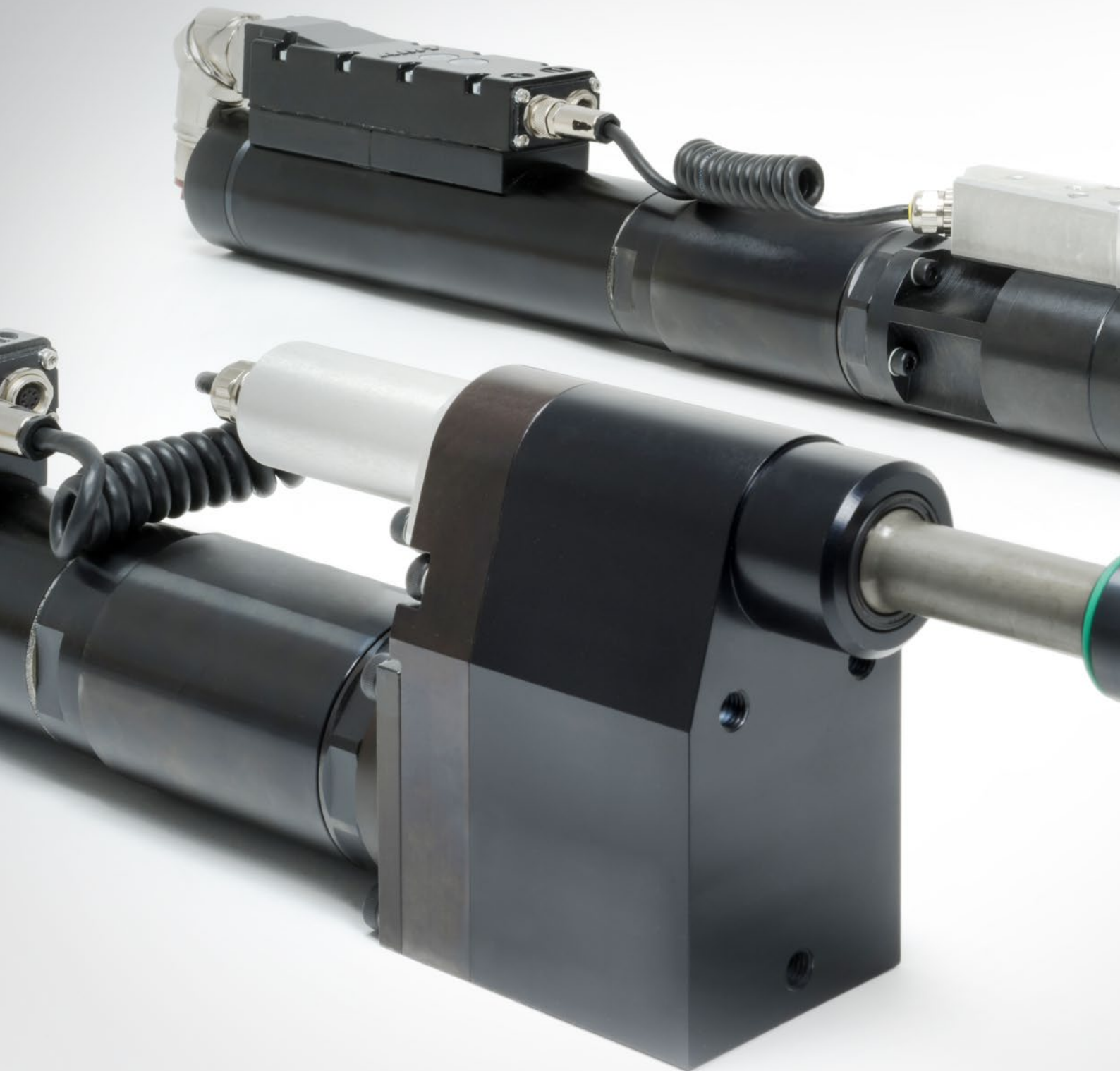







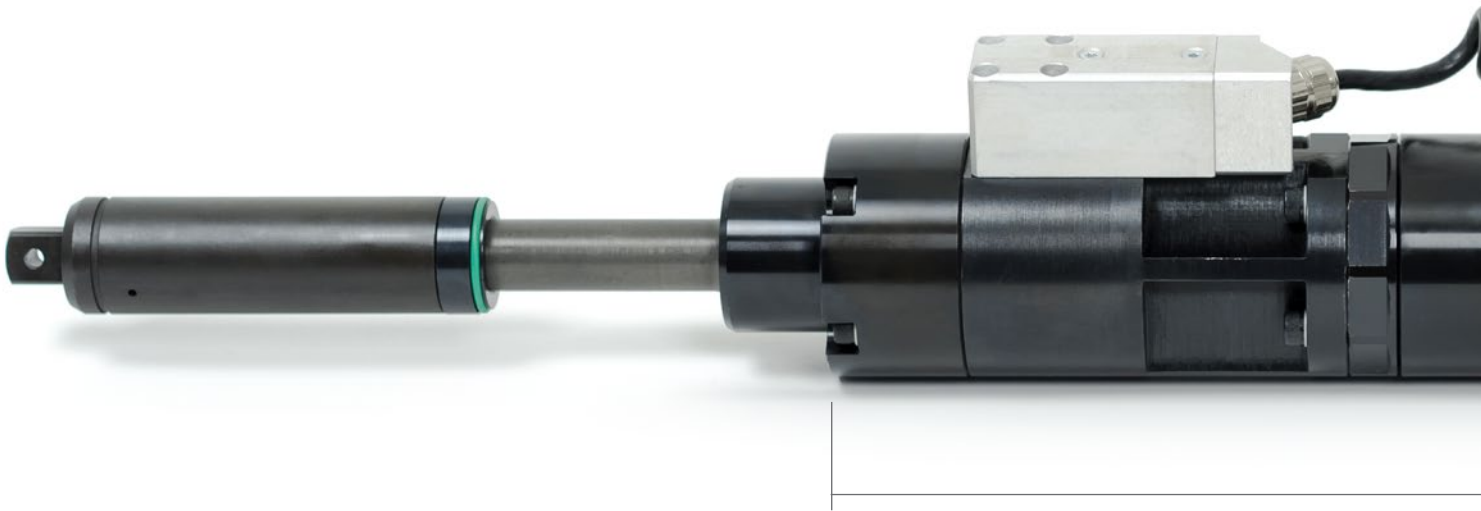

ESX CENTRIC OUTPUT

Technical key figures

Torque: 4 - 1300 Nm
Speed: up to 1200 1/min



Hole pattern table

Size	2-times  [mm]	3-times  [mm]	4-times  [mm]	5-times  [mm]	6-times  [mm]
Size 1	43	50	62	74	87
Size 2	59	69	84	101	118
Size 3	83	96	118	142	166
Size 4	88	102	125	150	176
Size 5	93	123	132	176	213

Key head is not included in the standard-delivery (See accessories)



Centric output with reaction torque center

Size	Type	Ident-no.	Torque range [Nm]	Speed max. [1/min.]	Length [mm]	Diameter [mm]	Weight [kg]
1	ESX103DRX40AZX150	70082420	6 - 37	1001	389.0	Ø42	3.9
	ESX106DRX65AZX150	70082421	10 - 63	599	389.0	Ø42	3.9
2	ESX206DRX140AZX250	70082422	21 - 62	1200	435.8	Ø58	6.8
	ESX213DRX140AZX250	70082423	21 - 135	533	470.9	Ø58	7.4
	ESX222DRX270AZX250	70082424	33 - 220	326	470.9	Ø58	7.4
	ESX227DRX270AZX250	70082425	41 - 270	266	493.5	Ø58	7.8
3	ESX329DRX300AZX350	70082426	44 - 291	486	511.5	Ø82	15.2
	ESX350DRX500AZX350	70082427	75 - 500	286	511.5	Ø82	15.2
4	ESX461DRX800AZX460	70082428	93 - 617	229	566.2	Ø87	18.1
	ESX480DRX800AZX460	70082429	120 - 800	172	566.2	Ø87	18.1
5	ESX5130DRX1300AZX580	70082430	195 - 1300	104	630.9	92 ²	25.5

Centric output with reaction torque sensor (only possibility for counter measurement)

Size	Type	Ident-no.	Torque range [Nm]	Speed max. [1/min.]	Length [mm]	Diameter [mm]	Weight [kg]
1	ESX103ZWRX40AZX150	70082431	6 - 37	1001	389.0	Ø42	3.9
	ESX106ZWRX65AZX150	70082432	10 - 63	599	389.0	Ø42	3.9
2	ESX206ZWRX140AZX250	70082433	21 - 62	1200	435.8	Ø58	6.9
	ESX213ZWRX140AZX250	70082434	21 - 135	533	470.9	Ø58	7.4
	ESX222ZWRX270AZX250	70082435	33 - 220	326	470.9	Ø58	7.4
	ESX227ZWRX270AZX250	70082436	41 - 270	266	493.5	Ø58	7.8
3	ESX329ZWRX300AZX350	70082437	44 - 291	486	511.5	Ø82	15.2
	ESX350ZWRX500AZX350	70082438	75 - 500	286	511.5	Ø82	15.2
4	ESX461ZWRX800AZX460	70082439	93 - 617	229	566.2	Ø87	18.2
	ESX480ZWRX800AZX460	70082440	120 - 800	172	566.2	Ø87	18.2
5	ESX5130ZWRX1300AZX580	70082441	195 - 1300	104	630.9	92 ²	25.5

Centric output with reaction torque sensor

Size	Type	Ident-no.	Torque range [Nm]	Speed max. [1/min.]	Length [mm]	Diameter [mm]	Weight [kg]
1	ESX103DAX40AZX150	70082442	4 - 37	1001	389.0	Ø42	3.8
	ESX106DAX65AZX150	70082443	7 - 63	599	389.0	Ø42	3.8
2	ESX206DAX140AZX250	70082444	14 - 62	1200	435.8	Ø58	6.7
	ESX213DAX140AZX250	70082445	14 - 135	533	470.9	Ø58	7.3
	ESX222DAX270AZX250	70082446	22 - 220	326	470.9	Ø58	7.3
	ESX227DAX270AZX250	70082447	27 - 270	266	493.5	Ø58	7.7
3	ESX329DAX300AZX350	70082448	30 - 291	486	511.5	Ø82	15.3
	ESX350DAX500AZX350	70082449	50 - 500	286	511.5	Ø82	15.3
4	ESX461DAX800AZX460	70082450	62 - 617	229	566.2	Ø87	18.1
	ESX480DAX800AZX460	70082451	80 - 800	172	566.2	Ø87	18.1
5	ESX5130DAX1300AZX580	70082452	130 - 1300	104	630.9	92 ²	25.4

Components overview given in page 22



Centric output with action torque sensor (Redundant construction)

Size	Type	Ident-no.	Torque range [Nm]	Speed max. [1/min.]	Length [mm]	Diameter [mm]	Weight [kg]
1	ESX103DRX40DWAX40AZX150	70082453	4 - 37	1001	479.0	Ø42	4.7
	ESX106DRX65DWAX65AZX150	70082454	7 - 63	599	479.0	Ø42	4.7
2	ESX206DRX140DWAX140AZX250	70082455	14 - 62	1200	525.8	Ø58	8.0
	ESX213DRX140DWAX140AZX250	70082456	14 - 135	533	560.9	Ø58	8.6
	ESX222DRX270DWAX270AZX250	70082457	22 - 220	326	560.9	Ø58	8.6
	ESX227DRX270DWAX270AZX250	70082458	27 - 270	266	583.5	Ø58	9.0
3	ESX329DRX300DWAX300AZX350	70082459	30 - 291	486	603.5	Ø82	17.7
	ESX350DRX500DWAX500AZX350	70082460	50 - 500	286	603.5	Ø82	17.7
4	ESX461DRX800DWAX800AZX460	70082461	62 - 617	229	666.2	Ø87	21.1
	ESX480DRX800DWAX800AZX460	70082462	80 - 800	172	666.2	Ø87	21.1
5	ESX5130DRX1300DWAX1300AZX580	70082463	130 - 1300	104	742.9	92 ²	30.2

Centric output with action torque sensor (Redundant construction and counter measurement)

Size	Type	Ident-no.	Torque range [Nm]	Speed max. [1/min.]	Length [mm]	Diameter [mm]	Weight [kg]
1	ESX103ZWRX40DWAX40AZX150	70082464	4 - 37	1001	479.0	Ø42	4.7
	ESX106ZWRX65DWAX65AZX150	70082465	7 - 63	599	479.0	Ø42	4.7
2	ESX206ZWRX140DWAX140AZX250	70082466	14 - 62	1200	525.8	Ø58	8.1
	ESX213ZWRX140DWAX140AZX250	70082467	14 - 135	533	560.9	Ø58	8.7
	ESX222ZWRX270DWAX270AZX250	70082468	22 - 220	326	560.9	Ø58	8.7
	ESX227ZWRX270DWAX270AZX250	70082469	27 - 270	266	583.5	Ø58	9.0
3	ESX329ZWRX300DWAX300AZX350	70082470	30 - 291	486	603.5	Ø82	17.8
	ESX350ZWRX500DWAX500AZX350	70082471	50 - 500	286	603.5	Ø82	17.8
4	ESX461ZWRX800DWAX800AZX460	70082472	62 - 617	229	666.2	Ø87	21.2
	ESX480ZWRX800DWAX800AZX460	70082473	80 - 800	172	666.2	Ø87	21.2
5	ESX5130ZWRX1300DWAX1300AZX580	70082474	130 - 1300	104	742.9	92 ²	30.2





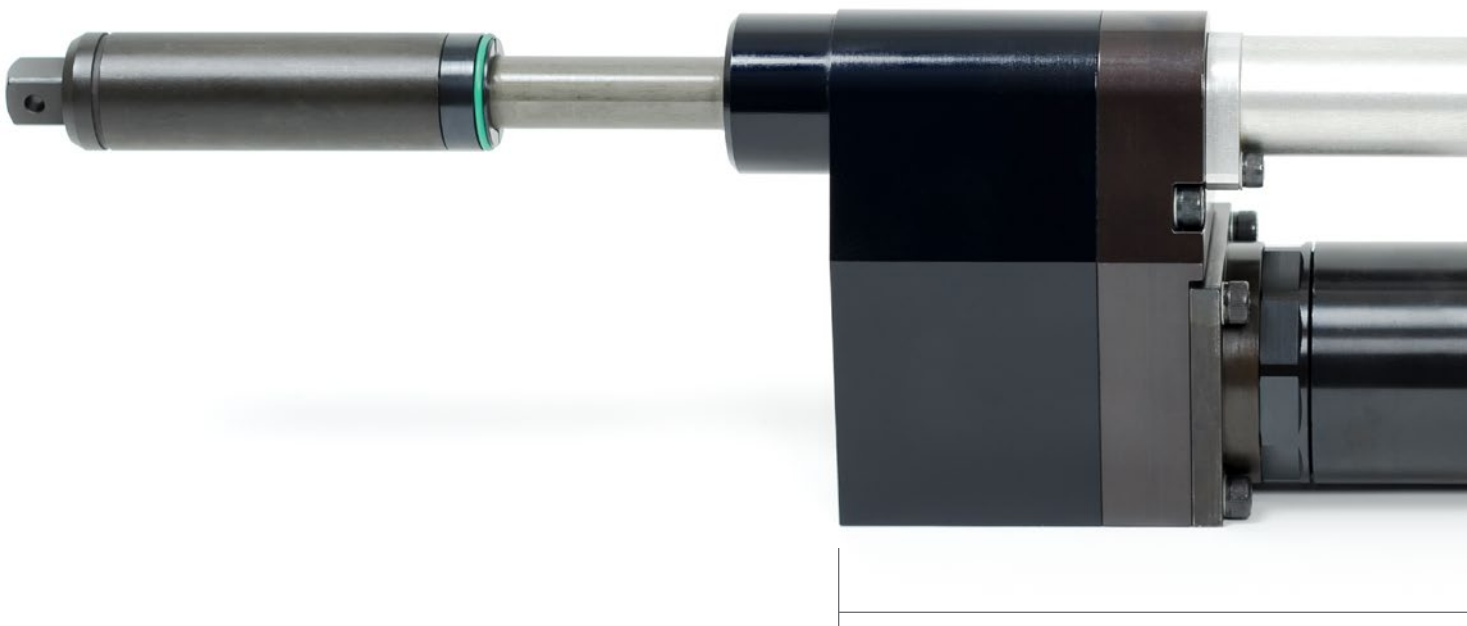

ESX OFFSET OUTPUT

Technical key figures

Torque: 4 - 1000 Nm
 Speed: up to 1114 1/min



Hole pattern table

Size	2-times  [mm]	3-times  [mm]	4-times  [mm]	5-times  [mm]	6-times  [mm]
Size 1	31	36	44	53	62
Size 2 (with AODX250-140 & AODX250-220)	41	48	58	70	82
Size 2 (with AODX250-270)	46	54	66	79	92
Size 3	51	59	73	87	102
Size 4 (with AODX460-800)	66	85	93	112	131
Size 4 (with AODX460-1000)	77	96	109	131	154

Key head is not included in the standard-delivery (See accessories)



Offset output with reaction torque sensor

Size	Type	Ident-no.	Torque range [Nm]	Speed max. [1/min.]	Length [mm]	Radius [mm]	Weight [kg]
1	ESX103AODX150-40	70082475	4 - 37	938	347.0	15	3.6
	ESX106AODX150-65	70082476	7 - 63	561	347.0	15	3.6
2	ESX206AODX250-140	70082477	14 - 62	1114	412.3	20	7.7
	ESX213AODX250-140	70082478	14 - 135	494	447.4	20	8.3
	ESX222AODX250-220	70082479	22 - 220	302	447.4	20	8.3
	ESX227AODX250-270	70082480	27 - 270	249	479.0	22.5	9.2
3	ESX329AODX350-300	70082481	30 - 291	448	515.2	25	16.9
	ESX350AODX350-500	70082482	50 - 500	264	515.2	25	16.9
4	ESX461AODX460-800	70082483	62 - 617	216	567.7	32.2	21.5
	ESX480AODX460-800	70082484	80 - 800	162	567.7	32.2	21.5
	ESX480AODX460-1000	70082485	100 - 1000	127	567.7	38	22.6

Offset output with action torque sensor (with reaction torque sensor for counter measurement)

Size	Type	Ident-no.	Torque range [Nm]	Speed max. [1/min.]	Length [mm]	Radius [mm]	Weight [kg]
1	ESX103ZWRX40AODX150-40	70082486	4 - 37	938	437.0	15	4.5
	ESX106ZWRX65AODX150-65	70082487	7 - 63	561	437.0	15	4.5
2	ESX206ZWRX140AODX250-140	70082488	14 - 62	1114	502.3	20	9.1
	ESX213ZWRX140AODX250-140	70082489	14 - 135	494	537.4	20	9.6
	ESX222ZWRX270AODX250-220	70082490	22 - 220	302	537.4	20	9.6
	ESX227ZWRX270AODX250-270	70082491	27 - 270	249	569.0	22.5	10.6
3	ESX329ZWRX300AODX350-300	70082492	30 - 291	448	607.2	25	19.3
	ESX350ZWRX500AODX350-500	70082493	50 - 500	264	607.2	25	19.3
4	ESX461ZWRX800AODX460-800	70082494	62 - 617	216	667.7	32.2	24.5
	ESX480ZWRX800AODX460-800	70082495	80 - 800	162	667.7	32.2	24.5
	ESX480ZWRX800AODX460-1000	70082496	100 - 1000	127	667.7	38	25.6

Offset output with action torque sensor (Redundant construction)

Size	Type	Ident-no.	Torque range [Nm]	Speed max. [1/min.]	Length [mm]	Radius [mm]	Weight [kg]
1	ESX103DRX40WX1AODX150-40	70082497	4 - 37	938	467.0	15	4.7
	ESX106DRX65WX1AODX150-65	70082498	7 - 63	561	467.0	15	4.7
2	ESX206DRX140WX2AODX250-140	70082499	14 - 62	1114	542.3	20	9.5
	ESX213DRX140WX2AODX250-140	70082500	14 - 135	494	577.4	20	10.0
	ESX222DRX270WX2AODX250-220	70082501	22 - 220	302	577.4	20	10.0
	ESX227DRX270WX2AODX250-270	70082502	27 - 270	249	609.0	22.5	11.0
3	ESX329DRX300WX3AODX350-300	70082503	30 - 291	448	652.2	25	20.1
	ESX350DRX500WX3AODX350-500	70082504	50 - 500	264	652.2	25	20.1
4	ESX461DRX800WX4AODX460-800	70082505	62 - 617	216	717.7	32.2	25.4
	ESX480DRX800WX4AODX460-800	70082506	80 - 800	162	717.7	32.2	25.4
	ESX480DRX800WX4AODX460-1000	70082507	100 - 1000	127	717.7	38	27.2

Offset output with action torque sensor (Redundant construction and counter measurement)

Size	Type	Ident-no.	Torque range [Nm]	Speed max. [1/min.]	Length [mm]	Radius [mm]	Weight [kg]
1	ESX103ZWRX40WX1AODX150-40	70082508	4 - 37	938	467.0	15	4.7
	ESX106ZWRX65WX1AODX150-65	70082509	7 - 63	561	467.0	15	4.7
2	ESX206ZWRX140WX2AODX250-140	70082510	14 - 62	1114	542.3	20	9.5
	ESX213ZWRX140WX2AODX250-140	70082511	14 - 135	494	577.4	20	10.1
	ESX222ZWRX270WX2AODX250-220	70082512	22 - 220	302	577.4	20	10.1
	ESX227ZWRX270WX2AODX250-270	70082513	27 - 270	249	609.0	22.5	11.0
3	ESX329ZWRX300WX3AODX350-300	70082514	30 - 291	448	652.2	25	20.1
	ESX350ZWRX500WX3AODX350-500	70082515	50 - 500	264	652.2	25	20.1
4	ESX461ZWRX800WX4AODX460-800	70082516	62 - 617	216	717.7	32.2	25.5
	ESX480ZWRX800WX4AODX460-800	70082517	80 - 800	162	717.7	32.2	25.5
	ESX480ZWRX800WX4AODX460-1000	70082518	100 - 1000	127	717.7	38	27.3

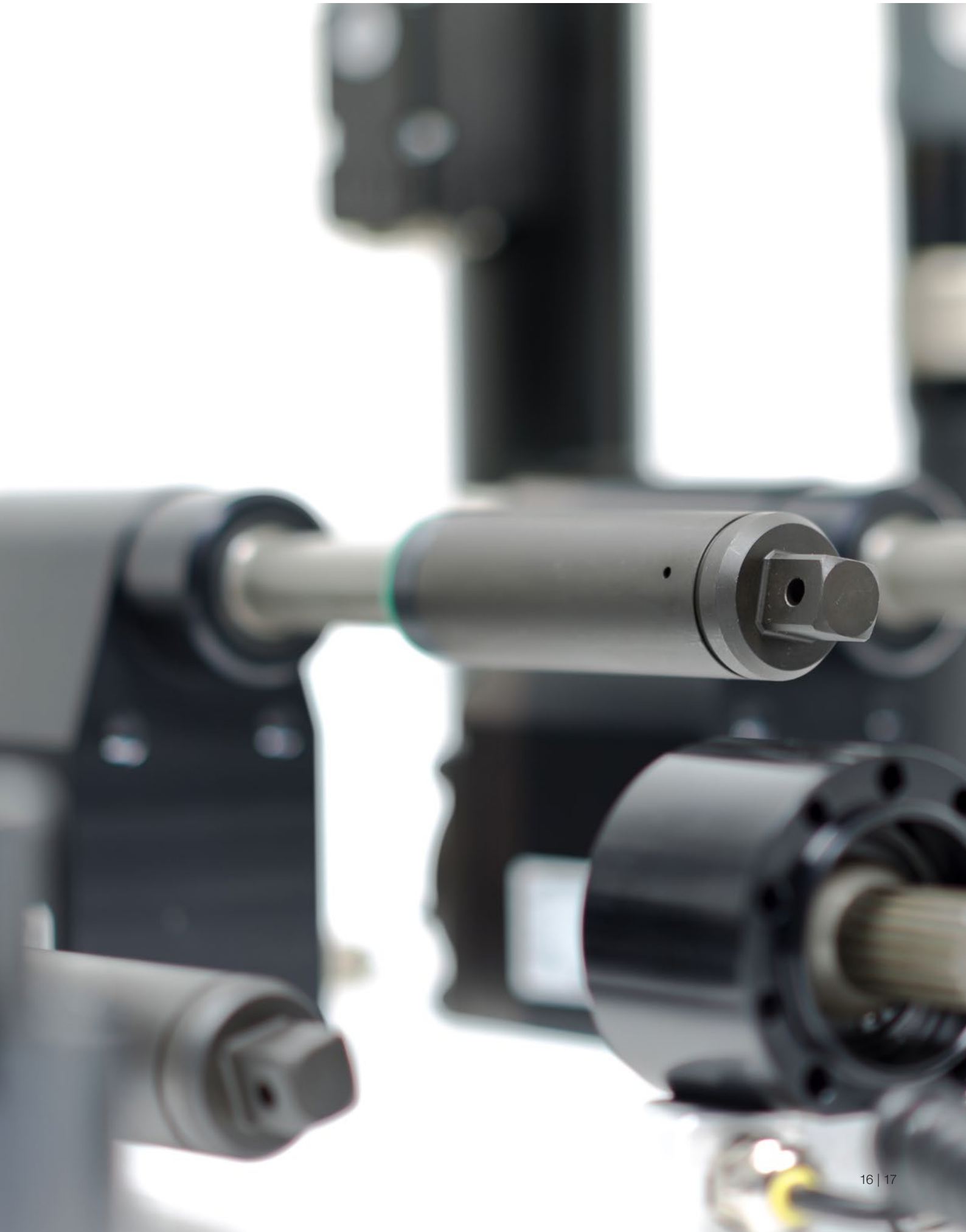

ESX ANGLE OUTPUT

Technical key figures

Torque: 4 - 800 Nm
Speed: up to 1136 1/min



Height

Key head is not included in the standard-delivery
(See accessories)

Angle output with action torque sensor

Size	Type	Ident-no.	Torque range [Nm]	Speed max. [1/min.]	Length [mm]	Height [mm]	Weight [kg]
1	ESX103AWDX150-40	70082519	4 - 37	929	349.5	98	4.5
	ESX106AWDX150-65	70082520	7 - 63	556	349.5	98	4.5
2	ESX206AWDX250-140	70082521	14 - 62	1136	398.3	124	8.8
	ESX213AWDX250-140	70082522	14 - 135	504	433.4	124	9.3
	ESX222AWDX250-270	70082523	22 - 220	308	433.4	124	9.3
	ESX227AWDX250-270	70082524	27 - 270	252	456.0	124	9.7
3	ESX329AWDX350-300	70082525	30 - 291	460	482.0	137	18.1
	ESX350AWDX350-500	70082526	50 - 500	270	482.0	137	18.1
4	ESX461AWDX460-800	70082527	62 - 617	211	541.2	151.5	23.8
	ESX480AWDX460-800	70082528	80 - 800	158	541.2	151.5	23.8

Components overview given in page 22

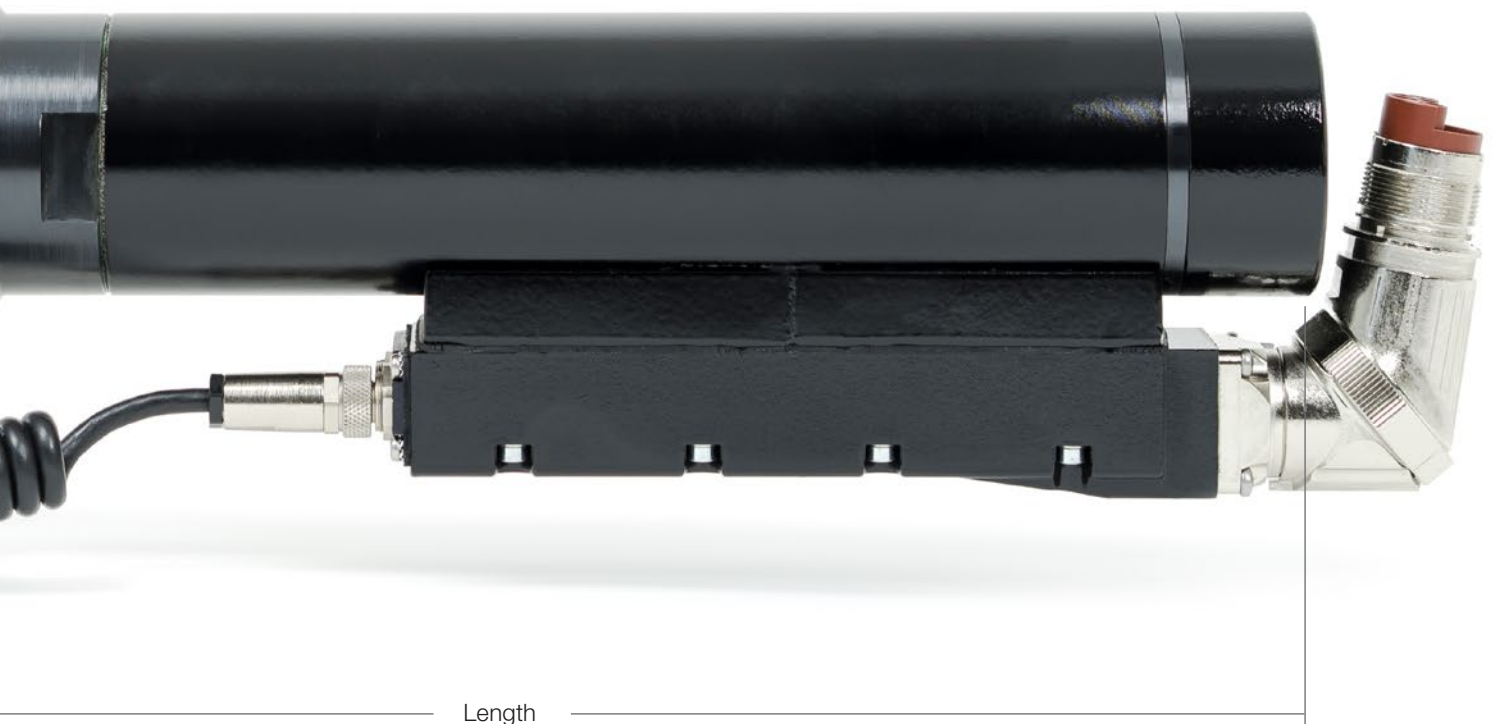

Angle output with action torque sensor (with reaction torque sensor for counter measurement)

Size	Type	Ident-no.	Torque range [Nm]	Speed max. [1/min.]	Length [mm]	Height [mm]	Weight [kg]
1	ESX103ZWRX40AWDX150-40	70082529	4 - 37	929	439.5	98	5.4
	ESX106ZWRX65AWDX150-65	70082530	7 - 63	556	439.5	98	5.4
2	ESX206ZWRX140AWDX250-140	70082531	14 - 62	1136	488.3	124	10.1
	ESX213ZWRX140AWDX250-140	70082532	14 - 135	504	523.4	124	10.7
	ESX222ZWRX270AWDX250-270	70082533	22 - 220	308	523.4	124	10.7
	ESX227ZWRX270AWDX250-270	70082534	27 - 270	252	546.0	124	11.1
3	ESX329ZWRX300AWDX350-300	70082535	30 - 291	460	574.0	137	20.6
	ESX350ZWRX500AWDX350-500	70082536	50 - 500	270	574.0	137	20.6
4	ESX461ZWRX800AWDX460-800	70082537	62 - 617	211	641.2	151.5	26.8
	ESX480ZWRX800AWDX460-800	70082538	80 - 800	158	641.2	151.5	26.8

Angle output with action torque sensor (Redundant construction)

Size	Type	Ident-no.	Torque range [Nm]	Speed max. [1/min.]	Length [mm]	Height [mm]	Weight [kg]
1	ESX103DRX40WX1AWDX150-40	70082539	4 - 37	929	469.5	98	5.6
	ESX106DRX65WX1AWDX150-65	70082540	7 - 63	556	469.5	98	5.6
2	ESX206DRX140WX2AWDX250-140	70082541	14 - 62	1136	528.3	124	10.5
	ESX213DRX140WX2AWDX250-140	70082542	14 - 135	504	563.4	124	11.1
	ESX222DRX270WX2AWDX250-270	70082543	22 - 220	308	563.4	124	11.1
	ESX227DRX270WX2AWDX250-270	70082544	27 - 270	252	586.0	124	11.4
3	ESX329DRX300WX3AWDX350-300	70082545	30 - 291	460	619.0	137	21.3
	ESX350DRX500WX3AWDX350-500	70082546	50 - 500	270	619.0	137	21.3
4	ESX461DRX800WX4AWDX460-800	70082547	62 - 617	211	691.2	151.5	27.7
	ESX480DRX800WX4AWDX460-800	70082548	80 - 800	158	691.2	151.5	27.7

Angle output with action torque sensor (Redundant construction and counter measurement)

Size	Type	Ident-no.	Torque range [Nm]	Speed max. [1/min.]	Length [mm]	Height [mm]	Weight [kg]
1	ESX103ZWRX40WX1AWDX150-40	70082549	4 - 37	929	469.5	98	5.6
	ESX106ZWRX65WX1AWDX150-65	70082550	7 - 63	556	469.5	98	5.6
2	ESX206ZWRX140WX2AWDX250-140	70082551	14 - 62	1136	528.3	124	10.5
	ESX213ZWRX140WX2AWDX250-140	70082552	14 - 135	504	563.4	124	11.1
	ESX222ZWRX270WX2AWDX250-270	70082553	22 - 220	308	563.4	124	11.1
	ESX227ZWRX270WX2AWDX250-270	70082554	27 - 270	252	586.0	124	11.5
3	ESX329ZWRX300WX3AWDX350-300	70082555	30 - 291	460	619.0	137	21.3
	ESX350ZWRX500WX3AWDX350-500	70082556	50 - 500	270	619.0	137	21.3
4	ESX461ZWRX800WX4AWDX460-800	70082557	62 - 617	211	691.2	151.5	27.8
	ESX480ZWRX800WX4AWDX460-800	70082558	80 - 800	158	691.2	151.5	27.8



COMPONENTS OVERVIEW

Base Spindle

By using new generation motors, the performance of the ESX Fixture Spindles could be increased by up to 16 % when compared to the proven ECR series of the same size. The motors additionally have a greatly improved level of efficiency.

This reduces the energy consumption per application as well as the heating up of the spindle. With the newly developed drive series, the output torque could be increased by up to 35 % with the same size. The innovative rotating joint hybrid connector can be gradually adjusted to fit the respective installation situation of the spindle.

Every angle can be gradually set between a straight cable connection and a nearly 90 degree connection. It is also possible to rotate the connector 330 degrees. Angle connectors on the spindle cable are now a thing of the past.

It is now significantly easier to maintain spare part inventory.



E	SX	1	06
	Series SX - SX-Series		06 - max. torque [Nm] / 10 (rounded)
E - Fixture Spindle		1 - Size (1 ... 5)	

Reaction transducer

The cost-effective torque sensors are installed between drive and output. The torque measurement is done indirectly via the reaction torque (reaction torque sensor). A ZWRX torque sensor has an additional torque and angle measuring system compared to a DRX torque sensor. Torque sensors of the DRX and ZWRX series are used in the control circuit, as a redundant torque sensor in conjunction with an action torque sensor or for counter-measurement via an external measuring case (ZWRX only). When using these torque sensors transversely to the axial direction, the acceleration/deceleration must not exceed 10 m/s².



				X - Suitable for SX-Series
	W - Integrated phase angle transmitter (only for dual circuit transducer)			65 - Transducer rating [Nm]
Z	W	R	X	65
		R - Reaction transducer		
D - Torque transducer				
Z - Dual circuit - Torque transducer				

Action transducer

The torque sensors of DAX- and DWAX-series are used for straight output. The torque is measured directly on the rotating output shaft (action torque sensor) and transmitted without contact to the evaluation electronics of the torque sensor. DWAX torque sensors have an integrated angle measuring system.

Torque sensors of the DAX and DWAX series enable a higher output torque and a wider range of use of the tool.



				X - Suitable for SX-Series
	W - Integrated angle transmitter (Option)			65 - Transducer rating [Nm]
D	W	A	X	65
		A - Action transducer		
D - Torque transducer				

Angle component

If an AODX offset gear or an AWDX - An angle measuring system is also required (e.g. for installing a redundant system) an angular assembly of the WX series is used.

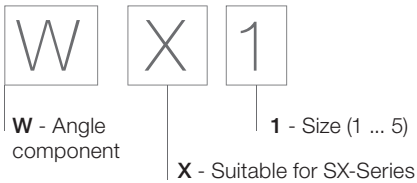

Outputs without measurement transducer

If no special requirements exist with respect to the geometry of the spindle, a centric output is used.

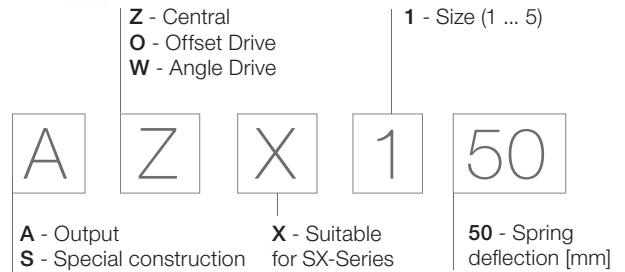
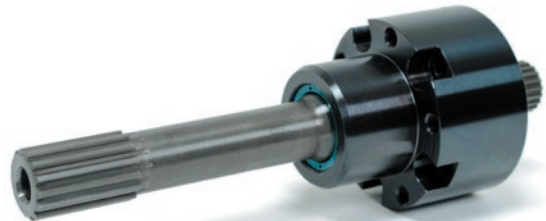

Outputs with measurement transducer

AODX - offset gearboxes and AWDX angle gearboxes have an integrated torque sensor. The torque is measured directly on the rotating output shaft (action torque sensor) and transmitted without contact to the evaluation electronics of the torque sensor.

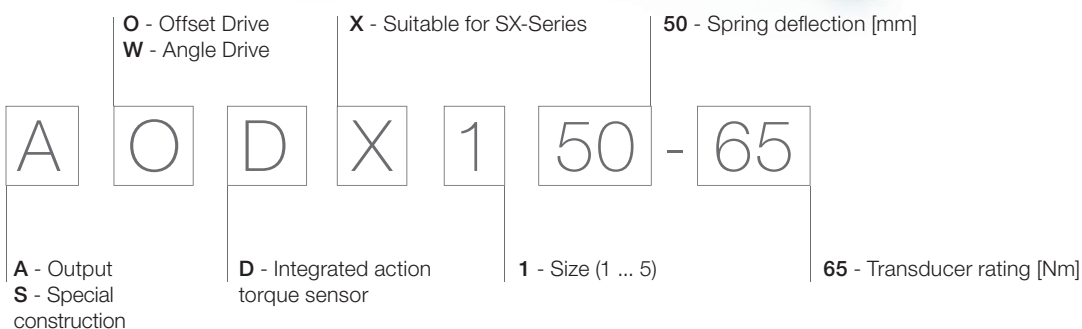
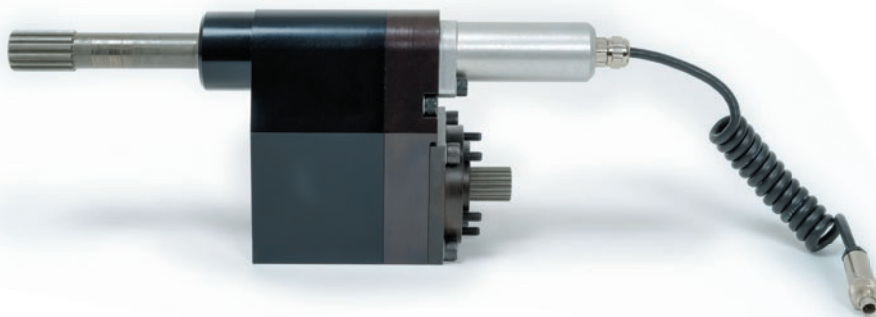

COMPACT NUTRUNNER KSX

Small, light, efficient

The new built-in nutrunners of the KSX series are ultra-compact and very light. They have been especially developed for use in applications where space requirements and the weight of the nutrunning equipment used are key factors.

Integrated status display

The status display integrated in the nutrunner combines several benefits. The operating and communication status as well as the quality statement of the last tightening operation are shown via LEDs. This significantly simplifies the error diagnosis and when using the nutrunner in a handling unit no separate display panel will be required.

Rotatable connector

The innovative rotatable connector can be freely adjusted to the assembly situation of the nutrunner.

Technical Data

General

- Digital communication with the controller
- Rotatable connector
- Integrated status display
- Reaction torque sensor
- Lowest possible rotation speed: 0 RPM
- Angle accuracy: $\pm 3^\circ$, absolute
- Tightening torque tolerance: $\pm 7\%$ at $\text{cm/cmK} \geq 1,67$



	Designation	Ident-No.	Torque [Nm]	Speed [1/min]	Weight [kg]	Length [mm]	Drive	Angle Head ø [mm]
Centric output	KSX1015ZV38	70121590	3 - 15	1008	1.04	173.3	□ 3/8"	
	KSX1025ZV38	70121591	5 - 25	771	1.04	173.3	□ 3/8"	
	KSX1048ZV38	70121592	10 - 48	381	1.15	193.8	□ 3/8"	
	KSX1015ZF25	70121593	3 - 15	1008	1.08	173.3	Spring travel 25 mm	
	KSX1025ZF25	70121594	5 - 25	771	1.08	173.3	Spring travel 25 mm	
	KSX1048ZF25	70121595	10 - 48	381	1.19	193.8	Spring travel 25 mm	
	KSX1015ZF50	70121596	3 - 15	1008	1.10	173.3	Spring travel 50 mm	
	KSX1025ZF50	70121597	5 - 25	771	1.10	173.3	Spring travel 50 mm	
	KSX1048ZF50	70121598	10 - 48	381	1.21	173.3	Spring travel 50 mm	
Offset output	KSX1015OV38	70121600	4 - 15	936	1.46	217.8	□ 3/8"	
	KSX1025OV38	70121601	7 - 25	716	1.46	217.8	□ 3/8"	
	KSX1048OV38	70121602	12 - 48	349	1.72	253.6	□ 3/8"	
	KSX1015OF25	70121603	4 - 15	936	1.50	217.8	Spring travel 25 mm	
	KSX1025OF25	70121604	7 - 25	716	1.50	217.8	Spring travel 25 mm	
	KSX1048OF25	70121605	12 - 48	349	1.76	253.6	Spring travel 25 mm	
	KSX1015OF50	70121606	4 - 15	936	1.52	217.8	Spring travel 50 mm	
	KSX1025OF50	70121607	7 - 25	716	1.52	217.8	Spring travel 50 mm	
	KSX1048OF50	70121608	12 - 48	349	1.78	253.6	Spring travel 50 mm	
Angle output	KSX1023WW38	70121609	6 - 23	775	1.77	275.4	□ 3/8"	28
	KSX1035WW38	70121610	9 - 35	514	1.84	275.4	□ 3/8"	33
	KSX1058WW38	70121611	15 - 58	299	2.35	322.9	□ 3/8"	38
	KSX1083WW12	70121612	21 - 83	199	2.44	327.4	□ 1/2"	45
	KSX1058WF25	70121613	15 - 58	299	2.45	322.9	Spring travel 25 mm	38
	KSX1083WF25	70121614	21 - 83	199	2.66	327.4	Spring travel 25 mm	45
	KSX1058WF50	70121615	15 - 58	299	2.47	322.9	Spring travel 50 mm	38
	KSX1083WF50	70121616	21 - 83	199	2.69	327.4	Spring travel 50 mm	45

Hole pattern table

Size

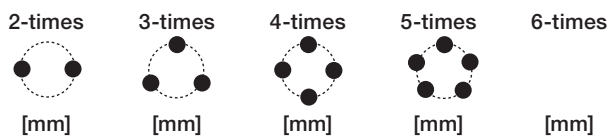

KSX-Spindles (Centric output)	41	55	58	77	94
KSX-Spindles (Offset output)	23	27	33	39	46

CONTROLS

A modular system architecture allows for individual solutions even for the most complex of demands. Five controllers are available for the realization of different customer requirements. The controls are designed for hand-held as well as for fixture spindles and multi-purpose nutrunners.

SMX100, SMX200, SMX300, SMX400

While developing our newest generation of controls for HSX handheld tools and ESX fixture spindles, the AMT developers follows a new approach. Instead of simply further developing existing controls, completely new control software was developed based on a completely new hardware platform. The following development goals were in focus:

- Use of a new, powerful hardware platform
- Direct communication of the control with mobile devices such as smartphones and tablets
- Simple operation of the control software
- Energy efficiency, this means clear savings in energy compared to the previous systems

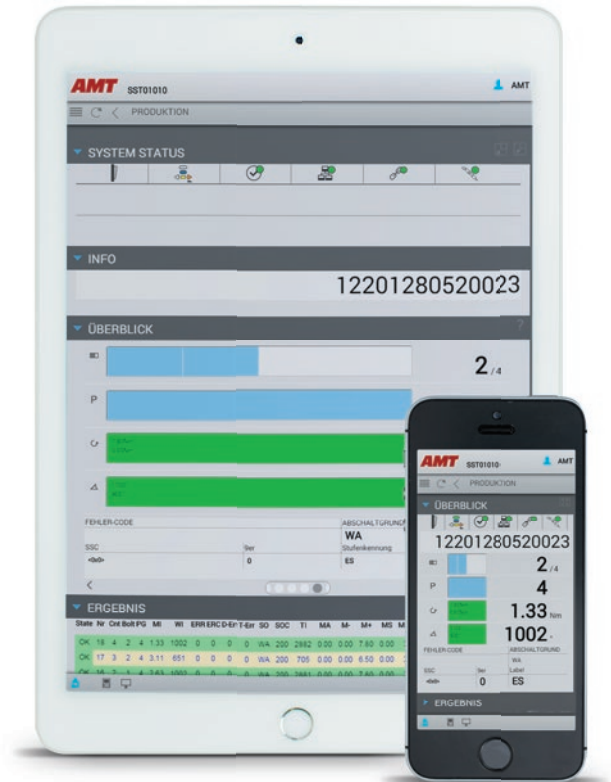

SMX100



SMX200



SMX300



SMX100, SMX200, SMX300, SMX400

While developing our newest generation of controls for HSX handheld tools and ESX fixture spindles, the AMT developers follow a new approach. Instead of simply further developing existing controls, completely new control software was developed based on a completely new hardware platform. The following development goals were in focus:

- Use of a new, powerful hardware platform
- Direct communication of the control with mobile devices such as smartphones and tablets
- Simple operation of the control software
- Energy efficiency, this means clear savings in energy compared to the previous systems

Scalable hardware

Due to the plug-in modules which can be plugged in from outside, controls can easily be arranged around interfaces, e.g. for various field bus systems. If this is used consistently, there is a reduction in the control variants and thus the number of spare parts.

Exchangeable storage medium

When replacing a controller, it is sufficient to transfer the Micro SD card to the new controller. The new control system thus automatically has the correct software status and the correct parameters. A software update or a parameter restore is not necessary.

Simple operation – new programming tools

A multitude of development and design work was placed in the new operating interfaces - for the easiest possible handling. It is characteristic for the three newly designed programming tools:

The Library contains a variety of premade algorithm programs from which the user can select the suitable program and use without further settings. New programs are created with the help of an Assistant. In just a few steps, the assistant guides the user through the program creation.

The fastening program is then automatically created and set. The graphic programming interface is ideal for very demanding tasks. Symbols are used here that the user drags to the desktop and puts together into a fastening process. Even complex programs can be created in a very clear and comprehensible manner through this.

SMX400



SMXC



CONTROL SMX100

The SMX100 is the base control of the SX-Series. It is a full-fledged single-channel controller with a variety of interfaces. The status visualization is carried out via a 7-segment display and four LEDs. The SMX100 has a high number of fastening and supervisory procedures as well as the possibility to control complex fastening sequences.

The SMX100 is used wherever no visualization is required on the control. In multichannel systems, the SMX100 works as a secondary controller under a master control (SMX300/SMX400).



Ident-no.	Type description
70085290	SMX100-40-0001-A
70085310	SMX100-60-0001-A

Single channel control

7 segment display and LEDs

Interfaces

- 1 x Ethernet
- 9 x digital output
- 10 x digital input
- 1 x RS232/422/485 for Ident systems
- 2 x USB Host for external equipment
- Field bus interface (optional)
- Integrated Safety

Software

Operating system, firmware and parameters on exchangeable MicroSD card

Electrical Requirements

SMX100/200/300/400 with 40 A
Peak Power, Single Phase

Rated Voltage: 230V AC +/-10 %
Rated Current (AMPS): 3A
Power Rating: 700 W

SMX100/200/300/400 with 60 A
Peak Power 3-Phase

Rated Voltage: 380 V AC bis 480 V AC +/-10 %
Rated Current (AMPS): 1.8 A
Power Rating: 1200 W

The rated power is in reference to the highest rated model above.

CONTROL SMX200

The SMX200 has the same performance features such as the SMX100, but also has a 7 inch touch LCD display. The control can be parameterized completely on site via this display. The content of the production image can be configured specifically for each application. A variety of production widgets are available for this purpose.



Ident-no.	Type description
70085330	SMX200-40-0101-A
70085350	SMX200-60-0101-A

Single channel control

7" Touch-LCD Display

Interfaces

- 1 x Ethernet
- 9 x digital output
- 10 x digital input
- 1 x RS232/422/485 for Ident systems
- 2 x USB Host for external equipment
- Field bus interface (optional)
- Integrated Safety

Software

Operating system, firmware and parameters on exchangeable MicroSD card

Electrical Requirements

SMX100/200/300/400 with 40 A
Peak Power, Single Phase

Rated Voltage: 230V AC +/-10 %
Rated Current (AMPS): 3A
Power Rating: 700 W

SMX100/200/300/400 with 60 A
Peak Power 3-Phase

Rated Voltage: 380 V AC bis 480 V AC +/-10 %
Rated Current (AMPS): 1.8 A
Power Rating: 1200 W

The rated power is in reference to the highest rated model above.

CONTROL SMX300

The SMX300 is a master control. The SMX300 takes over the control in multi-channel spindle systems of the first spindle channel as well as the synchronization of the Secondary Controller. Up to 98 SMX100 controllers can be connected to the SMX300. The SMX300 offers additional interfaces as the master control compared with the basic controlling. The status and value can be seen on the 6.5 inch touch LCD display, which also allows parameter adjustments.



Ident-no.	Type description
70085370	SMX300-40-0401-A
70085390	SMX300-60-0401-A

Single channel control - master control
6.5" Touch-LCD Display
Integrated PC

Interfaces

- 2 x Ethernet
- 9 x digital output
- 10 x digital input
- 4 x RS232/422/485 for Ident systems
- 6 x USB Host for external equipment
- Field bus interface (optional)
- Integrated Safety

Software

Operating system, firmware and parameters on exchangeable MicroSD card / CF-card

Electrical Requirements

SMX100/200/300/400 with 40 A
Peak Power, Single Phase

Rated Voltage: 230V AC +/-10 %
Rated Current (AMPS): 3A
Power Rating: 700 W

SMX100/200/300/400 with 60 A
Peak Power 3-Phase

Rated Voltage: 380 V AC bis 480 V AC +/-10 %
Rated Current (AMPS): 1.8 A
Power Rating: 1200 W

The rated power is in reference to the highest rated model above.

CONTROL SMX400

The SMX400 has the same features as the SMX300, but has a 10.4 inch touch LCD display. Using this, the display can be parameterized completely on site via this display. The 10.4 inch touch LCD display allows for large-area display Production-related information.

Electrical Requirements

SMX100/200/300/400 with 40 A Peak Power, Single Phase

Rated Voltage: 230V AC +/-10 %

Rated Current (AMPS): 3A

Power Rating: 700 W

SMX100/200/300/400 with 60 A Peak Power 3-Phase

Rated Voltage: 380 V AC bis 480 V AC +/-10 %

Rated Current (AMPS): 1.8 A

Power Rating: 1200 W

The rated power is in reference to the highest rated model above.

Ident-no.	Type description
70085410	SMX400-40-0401-A
70085430	SMX400-60-0401-A

Interfaces

2 x Ethernet

9 x digital output

10 x digital input

4 x RS232/422/485 for Ident systems

6 x USB Host for external equipment

Field bus interface (optional)

Integrated Safety

Software

Operating system, firmware and

parameters on exchangeable

MicroSD card / CF-card



MULTIPLE CHANNEL CONTROL

SMXC – switch cabinet based multichannel control

With high-channel nutrunner systems, the design of the control as a switch cabinet solution is frequently the best solution for saving space.

The SMXC control allows for the construction of multichannel controls in a control cabinet.

- SMXC for handheld nutrunners: up to 10 screw channels
- SMXC for fixture spindles: up to 99 screw channels

An industrial PC for the master functions and one fastening module per spindle channel form the basis of the SMXC system. The master PC coordinates the connected fastening modules and forms the external interface. Through the master PC, the communication possibilities of the SMXC control are nearly unlimited. Interfaces like Ethernet, field bus, RS232, RS485 and USB are available.

Ident-no.	Type description
-----------	------------------

70063109	SMX100C-40-0001
----------	-----------------

70063110	SMX100C-60-0001
----------	-----------------

70128268	Master-PC H1 i5 Visu
----------	----------------------

70129287	Master-PC H1 i5
----------	-----------------



MODEL CODE

Model code SMX-fastening control

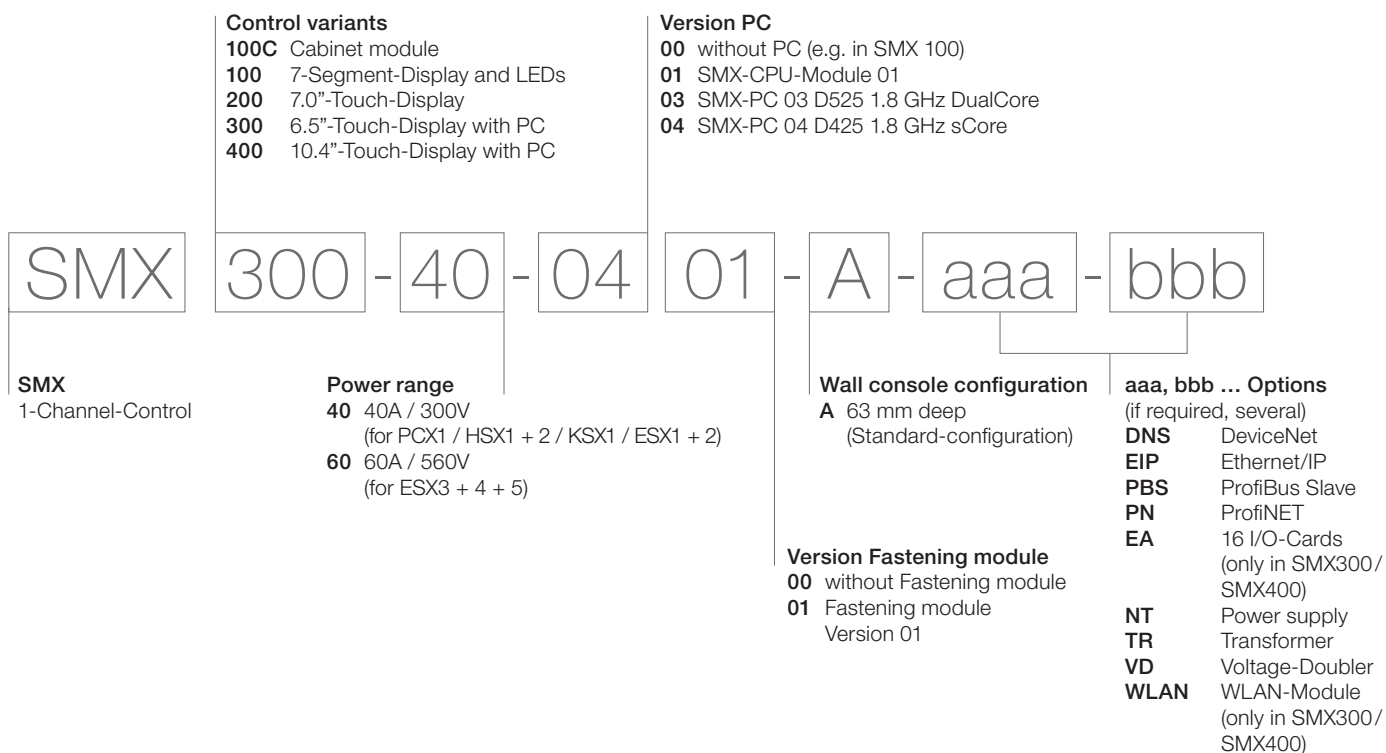

	SMX 100-40..	SMX 100-60..	SMX 200-40..	SMX 200-60..	SMX 300-40..	SMX 300-60..	SMX 400-40..	SMX 400-60..	SMX 100C-40..	SMX 100C-60..
PSX1	•		•		•		•		•	
HSX1	•		•		•		•		•	
HSX2	•		•		•		•		•	
KSX1	•		•		•		•		•	
ESX1	•		•		•		•		•	
ESX2	•		•		•		•		•	
ESX3		•		•		•		•		•
ESX4		•		•		•		•		•
ESX5		•		•		•		•		•

CABLE AND ACCESSORIES





CABLES



Standard Extension Cables (High Flex)

Used for Tool and Extension Cable

Diameter: ca. 12,5 mm

Minimum Bend Radius:

Fixed Installed: 5 x Cable - \varnothing
 Cat Track Installation minimum: 7.5 x Cable- \varnothing
 Cat Track Recommended: 12 x Cable- \varnothing

Cable Weight per Meter: 219 g/m

Weight of Connector: 105 g
 (Male End, Controller End)

Weight of Connector: 132 g
 (Nutrunner End)

Length [m]	Identification No.
2	70112802
3	70112803
5	70112805
7	70112807
10	70112810
15	70112815
20	70112820
25	70112825
30	70112830
35	70112835
40	70112840
*	70058271

Extension Cable – High Flex (Robot Application)

Diameter: ca. 14,0 mm

Minimum Bend Radius:

Fixed Installed: 3 x Cable - \varnothing
 Cat Track Installation minimum: 5 x Cable- \varnothing
 Cat Track Recommended: 10 x Cable- \varnothing
 Rotation/Twist: +/- 180 °/m)

Cable Weight per Meter: 228 g/m
 (for example: 70058270)

Weight of Connector: 105 g
 (Male End, Controller End)

Weight of Connector: 132 g
 (Nutrunner End)

Length [m]	Identification No.
2	70112702
3	70112703
5	70112705
7	70112707
10	70112710
15	70112715
**	70058270

Tool Cable for Robot Application

Diameter: ca. 7,7 mm (2x)

Minimum Bend Radius:

Fixed Installed: 2 x Cable - \varnothing
 Cat Track Installation minimum: 5 x Cable- \varnothing
 Cat Track Recommended: 10 x Cable- \varnothing
 Rotation/Twist: +/- 180 °/m)

Cable Weight per Meter: 173 g/m

Weight of Connector: 105 g
 (Controller End)

Weight of Connector: 30 g (2x)
 (Nutrunner End)

Length [m]	Identification No.
1	70125001
2	70125002
3	70125003
5	70125005
7	70125007
10	70125010
***	70125000

* Length must be specified while placing the order, Maximum cable length including Tool cable 45 m.
 ** Length must be specified while placing the order, Maximum cable length including Tool cable 15 m.
 *** Rotation/Twist +/- 180°/m. Maximum Length of Cable: 15 M.

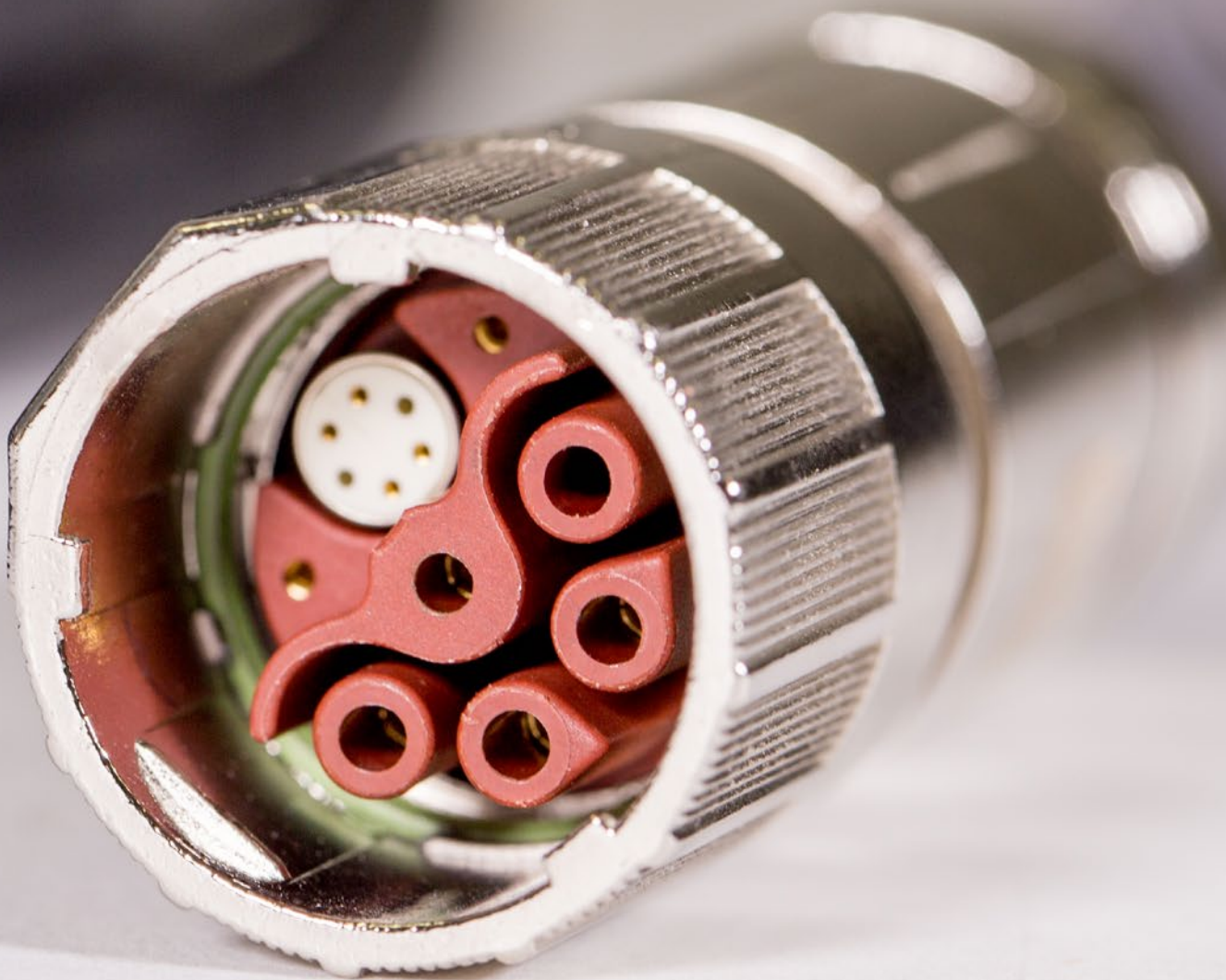

ACCESSORIES

Key heads *



Size	Type	Ident-no.	Spring tension		Suitable for type	Torque max. [Nm]
			min. [N]	max. [N]		
1	SK1-3/8"-50	7002230	12	30	ESX 1	63
	SK1-3/8"-50	7040068	17	44	ESX 1	63
2	SK2-1/2"-50	7002049	20	40	ESX2	165
	SK2-1/2"-50	7002059	40	80	ESX2	165
	SK2-5/8"-50	7004768	20	40	ESX2	300
	SK2-5/8"-50	70098963	40	80	ESX2	300
3	SK3-3/4"-50	7002133	20	40	ESX 3	560
	SK3-3/4"-50	70008386	40	80	ESX 3	560
4	SK3-1"-60	7006176	24	72	ESX4	1300
	SK3-1"-60	70015115	30	130	ESX4	1300
5	SK4-1"-80	7002956	30	80	ESX5	1300

Motor angle gear

By the deflection of the drive train via a motor angle gear, the overall length is significantly reduced.

Size	Type	Length reduction [mm]	Ident-no.
1	U1	141	70082315
2	U2	182	70082316
3+4+5	U3	190	70082317



Operating handles *

Operating handles with radial or axial switches. Also available with lever switch if requested. Signal output electrical or pneumatic. Due to their modular design, up to four buttons can be connected to one control handle. A combination of electrical and pneumatic configuration is possible. Variable fastening system that can be adjusted easily on site.



Telescope *

From the simple standard telescope in lightweight construction (carbon) to the complex handling with semi-automatic and fully automatic processes, everything is possible. Due to the modular design, special designs are also available for simple applications at a short notice.

We are the specialists in designing systems for demanding applications with multiple pullouts, built-in brackets, workpiece recognition, screw-in-point checks, presetting as well as automatic return to home position.



* Various designs available upon request

The exclusive rights to manufacturing methods, designations, designs, and representations for the products found in this catalog remain with Alfing Montagetechnik GmbH. Any reproduction is subject to civil and penal prosecution. Unauthorized reproduction of any kind, including only excerpts, is prohibited. All rights to modify engineering design, dimensions, and specifications are reserved. Every effort was made to check this publication for accuracy. However, no liability shall be assumed for any errors or omissions that might occur in this information. All rights to modify this information are reserved, due to the continuous development of our products.

Version 2019/09

AMT

Alfing Montagetechnik GmbH
Auguste-Kessler-Str. 20
D-73433 Aalen
Postfach 3105, D-73413 Aalen
Germany

e-Mail: vertrieb@amt.alfing.de



www.aks-amt.alfing.de